

# KENWOOD

**KRC-865**

CASSETTE RECEIVER  
**INSTRUCTION MANUAL**

KENWOOD CORPORATION

## Contents

<b>Safety precautions.....</b>	<b>3</b>		
<b>About Cassette tape.....</b>	<b>4</b>		
<b>General features .....</b>	<b>5</b>		
Power			
Selecting the Source			
Volume			
Attenuator			
Loudness			
System Q			
Audio Control			
Speaker Setting			
Switching Display			
Switching Clock Display			
Station/Diac Naming (SNPS/DNPS)			
Auxiliary Input Display Setting			
Faceplate Angle Adjustment			
Theft Deterrent Faceplate			
Hiding the Control Panel			
<b>Tuner features.....</b>	<b>10</b>		
Tuning Mode			
Tuning			
Direct Access Tuning			
Station Preset Memory			
Auto Memory Entry			
Preset Tuning			
Frequency Step Setting			
<b>Cassette player features.....</b>	<b>12</b>		
Playing Cassette Tapes			
Fast Forwarding and Rewinding			
Dolby B NR			
		Selecting the Tape type	
		DPSS (Direct Program Search System)	
		DPSS with the Remote	
		Blank Skip	
		Music Repeat	
		<b>External disc control features..</b>	<b>14</b>
		Playing External Disc	
		Fast Forwarding and Reversing	
		Track Search	
		Album Search	
		Direct Track Search	
		Direct Album Search	
		Track/Album Repeat	
		Track Scan	
		Random Play	
		Magazine Random Play	
		Text/Title Scroll	
		DNPP (Disc Name Preset Play)	
		<b>Menu system.....</b>	<b>17</b>
		Menu System	
		Security Code	
		Touch Sensor Tone	
		Manual Clock Adjustment	
		Selectable Illumination	
		Switching Graphic Display	
		Contrast Adjustment	
		Dimmer	
		OFF Wait Time Setting	
		System Q	
		B.M.S. (Bass Management System)	
		CRSC (Clean Reception System Circuit)	
		Text Scroll	
		<b>Basic Operations of remote.....</b>	<b>21</b>
		Loading and Replacing the battery	
		Basic operations	
		In Tuner source	
		In Cassette tape source	
		In Disc source	
		<b>Accessories.....</b>	<b>23</b>
		<b>Installation Procedure .....</b>	<b>23</b>
		<b>Connecting Wires to Terminals ...</b>	<b>24</b>
		.....	<b>24</b>
		<b>Installation (non-Japanese cars) ..</b>	<b>25</b>
		.....	<b>25</b>
		<b>Installation (Japanese cars) .....</b>	<b>25</b>
		<b>Removing the Unit .....</b>	<b>26</b>
		<b>Locking the faceplate to the unit</b>	<b>26</b>
		.....	<b>26</b>
		<b>Troubleshooting Guide .....</b>	<b>27</b>
		<b>Specifications .....</b>	<b>30</b>

## Safety precautions

### **▲WARNING**

**To prevent injury or fire, take the following precautions:**

- Insert the unit all the way in until it is fully locked in place. Otherwise it may fall out of place when jolted.
- When extending the ignition, battery, or ground wires, make sure to use automotive-grade wires or other wires with a 0.75mm<sup>2</sup> (AWG18) or more to prevent wire deterioration and damage to the wire coating.
- To prevent a short circuit, never put or leave any metallic objects (such as coins or metal tools) inside the unit.
- If the unit starts to emit smoke or strange smells, turn off the power immediately and consult your Kenwood dealer.
- Make sure not to get your fingers caught between the faceplate and the unit.
- Be careful not to drop the unit or subject it to strong shock.  
The unit may break or crack because it contains glass parts.
- Do not touch the liquid crystal fluid if the LCD is damaged or broken due to shock. The liquid crystal fluid may be dangerous to your health or even fatal.  
If the liquid crystal fluid from the LCD contacts your body or clothing, wash it off with soap immediately.

### **▲CAUTION**

**To prevent damage to the machine, take the following precautions:**

- Make sure to ground the unit to a negative 12V DC power supply.
- Do not open the top or bottom covers of the unit.
- Do not install the unit in a spot exposed to direct sunlight or excessive heat or humidity. Also avoid places with too much dust or the possibility of water splashing.
- Do not subject the faceplate to excessive shock, as it is a piece of precision equipment.
- When replacing a fuse, only use a new one with the prescribed rating. Using a fuse with the wrong rating may cause your unit to malfunction.
- To prevent a short circuit when replacing a fuse, first disconnect the wiring harness.
- Do not place any object between the faceplate and the unit.
- Do not use your own screws. Use only the screws provided. If you use the wrong screws, you could damage the unit.
- Do not apply excessive force to the moving faceplate. Doing so will cause damage or malfunction.
- Do not apply excessive force to the open faceplate or place objects on it. Doing so will cause damage or breakdown.

### **IMPORTANT INFORMATION**

**About the disc changer/CD player to be connected:**

To connect a disc changer having the "O-N" switch to this unit, set the "O-N" switch to "N". When you connect a model with no "O-N" switch, the converter cord CA-DS100 available as an option may be required. For details, consult your Kenwood dealer.

A disc changer doesn't work when it is connected without using these options. If a model with no "O-N" switch is connected, some unavailable functions and information that cannot be displayed are generated. Note that none of the KDC-C100, KDC-C302, C205, C705, and non-Kenwood CD changers can be connected.



You can damage both your unit and the CD changer if you connect them incorrectly.

*Manufactured under license from Dolby Laboratories.  
"Dolby" and the double-D symbol are trademarks of Dolby Laboratories.*

## Safety precautions

### NOTE

- If you experience problems during installation, consult your Kenwood dealer.
- If the unit fails to operate properly, press the Reset button. The unit returns to factory settings when the Reset button is pressed. If the unit still fails to operate properly after the Reset button has been pressed, contact your local KENWOOD dealer for assistance.
- Press the reset button if the disc auto changer fails to operate correctly. Normal operatin should be restored.

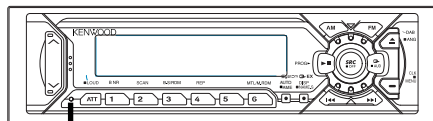

Reset button

- We recommend the use of the Security Code function (see p.18) to prevent theft.
- Characters in the LCD may become difficult to read in temperatures below 41 °F (5 °C).
- The illustrations of the display and the panel appearing in this manual are examples used to explain more clearly how the controls are used. Therefore, what appears on the display in the illustrations may differ from what appears on the display on the actual equipment, and some of the illustrations on the display may represent something impossible in actual operation.

### Cleaning the Faceplate Terminals

If the terminals on the unit or faceplate get dirty, wipe them with a dry, soft cloth.

### Cleaning the Unit

If the faceplate of this unit is stained, wipe it with a dry soft cloth such as a silicon cloth. If the faceplate is stained badly, wipe the stain off with a cloth moistened with neutral cleaner, then wipe neutral detergent off.



Applying spray cleaner directly to the unit may affect its mechanical parts. Wiping the faceplate with a hard cloth or using a volatile liquid such as thinner or alcohol may scratch the surface or erases characters.

## About Cassette tape

### Cleaning the tape head

When there's noise or the sound quality is bad during tape play the tape head maybe dirty, clean the tape head.

### About Cassette tape

- If the tape is slack tighten it.
- If the cassette tape label is peeling off glue it on again.
- Don't use deformed cassette tape.
- Don't place cassette tape on the dashboard etc. where the temperature is high.
- Don't use cassette tape that's 100 minutes long or longer.

## General features

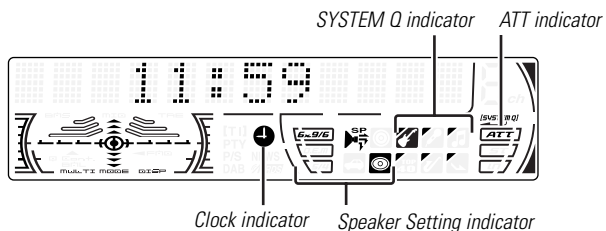
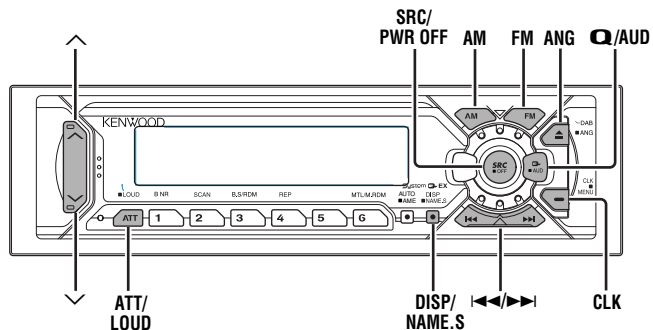

## Power

### Turning ON the Power

Press the [SRC] button.

### Turning OFF the Power

Press the [SRC] button for at least 1 second.

## Selecting the Source

Press the [SRC] button.

Source required	Display
Tuner	"TUNER"
Tape	"TAPE"
External disc	"DISC"
Auxiliary input	"AUX"
Standby (Illumination only mode)	"ALL OFF"



For Auxiliary input one of the below optional accessories is necessary.

- KCA-S210A
- CA-C1AX
- CD changer with an Auxiliary input function installed.

## Volume

### Increasing Volume

Press the [^] button.

### Decreasing Volume

Press the [v] button.

## General features

### Attenuator

Turning the volume down quickly.

Press the [ATT] button.

Each time the button is pressed the Attenuator turns ON or OFF. When it's ON, the "ATT" indicator blinks.

### Loudness

Compensating for low and high tones during low volume.

Press the [LOUD] button for at least 1 second.

Each time the button is pressed for at least 1 second the Loudness turns ON or OFF.

When it's ON, "LOUD ON" is displayed.

### System Q

You can recall the best sound setting preset for different types of the music.

#### 1 Select the source to set

Press the [SRC] button.

#### 2 Select the Sound type

Press the [Q] button.

Each time the button is pressed the sound setting switches.

Sound setting	Display
Flat	"Flat"
Rock	"Rock"
Top 40	"Top 40"
Pops	"Pops"
Jazz	"Jazz"
Easy	"Easy"
Scan of Flat — Easy	"Scan"

### User memory

"User"



- User memory: The values set on the <Audio control> (page 6).
- Each setting value is changed with the <Speaker setting> (page 7).

First, select the speaker type with the Speaker setting.

## Audio Control

### 1 Select the source for adjustment

Press the [SRC] button.

### 2 Enter Audio Control mode

Press the [AUD] button for at least 1 second.

### 3 Select the Audio item for adjustment

Press the [FM] or [AM] button.

Each time the button is pressed the items that can be adjusted switch as shown below.

### 4 Adjust the Audio item

Press the [◀◀] or [▶▶] button.

Adjustment Item	Display	Range
Bass Center Frequency	"Bass F"	60/70/80/100 or 150 Hz
Bass level	"Bass"	-8 — +8
Bass Q Factor	"Bass Q"	1.00/1.25/1.50/2.00
Bass Extend	"Bass EXT"	ON/OFF
Middle Center Frequency	"MID F"	0.5/1.0/1.5/2.0 kHz
Middle level	"Middle"	-8 — +8
Middle Q Factor	"Middle Q"	1.0/2.0
Treble Center Frequency	"TRE F"	10.0/12.5/15.0/17.5 kHz
Treble level	"Treble"	-8 — +8
Balance	"Balance"	Left 15 — Right 15
Fader	"Fader"	Rear 15 — Front 15
Volume offset	"V Offset"	-8 — ±0



- According to the Bass Q Factor setting value, the frequencies that can be set in Bass Center Frequency change as shown below.

<b>Bass Q Factor</b>	<b>Bass Center Frequency</b>
1.00/1.25/1.50	60/70/80/100
2.00	60/70/80/150

- When the Bass Extend is set to ON, low frequency response is extended by 20%.
- Volume offset: Each source's volume can be set as a difference from the basic volume.

## 5 Exit Audio Control mode

Press the [AUD] button.

## Speaker Setting

Fine-tuning so that the System Q value is optimal when setting the speaker type.

### 1 Enter Standby

Press the [SRC] button.  
Select the "ALL OFF" display.

### 2 Enter Speaker Setting mode

Press the [Q] button.

### 3 Select the Speaker type

Press the [◀◀] or [▶▶] button.  
Each time the button is pressed the setting switches as shown below.

<b>Speaker type</b>	<b>Display</b>
OFF	"SP OFF"
For 6 & 6x9 in. speaker	"SP 6*9/6inch"
For 5 & 4 in. speaker	"SP 5/4inch"
For the OEM speaker	"SP O.E.M."

### 4 Exit Speaker Setting mode

Press the [Q] button.

## Switching Display

Switching the information displayed.

Press the [DISP] button.

Each time the button is pressed the display switches as shown below.

### In Tuner source

<b>Information</b>	<b>Display</b>
Frequency	
Station name	"SNPS"

### In Tape source

<b>Information</b>	
Play side & Tape counter	
Play side & Tape running	
Play side	

### In External disc source

<b>Information</b>	<b>Display</b>
Track Time	
Disc name	"DNPS"
Disc title	"D-TITLE"
Track title	"T-TITLE"

## General features

### Switching Clock Display

Switching the displayed information.

Press the [CLK] button.

Each time the button is pressed it switches between clock display and current source.

During clock display the clock indicator is ON.

### Station/Disc Naming (SNPS/DNPS)

Attaching a title to a Station or CD.

#### 1 Receive/play the station/disc you want to attach a title to



- A title can't be attached to a MD.
- Disc Naming can't be done during CD text display.

#### 2 Enter name set mode

Press the [NAME.S] button for at least 2 seconds.

"NAME SET" is displayed.

#### 3 Move the cursor to the enter character position

Press the [◀] or [▶] button.

#### 4 Select the character type

Press the [▶II] button.

Each time the button is pressed the character type switches as shown below.

##### Character type

Alphabet upper case

Alphabet lower case

Numbers and symbols

Special characters (Accent characters)

#### 5 Select the characters

Press the [FM] or [AM] button.



Characters can be entered by using a remote with a number buttons.

Example: If "DANCE" is entered.

Character	Button	#Times pressed
"D"	[#3]	1
"A"	[#2]	1
"N"	[#6]	2
"C"	[#2]	3
"E"	[#3]	2

**6** Repeat steps 3 through 5 and enter the name.

#### 7 Exit name set mode

Press the [NAME.S] button.



- When operation stops for 10 seconds the name at that time is registered, and Name Set mode closes.
- Memory numbers
  - FM: 32 stations
  - AM: 16 stations
  - External CD changer/ player: Varies according to the CD changer/ player. Refer to the CD changer/ player manual.
- The title of station/CD can be changed by the same operation used to name it.

### Auxiliary Input Display Setting

Selecting the display when this device is switched to Auxiliary input source.

#### 1 Select Auxiliary input source

Press the [SRC] button.

Select the "AUX" display.

#### 2 Enter Auxiliary input display setting mode

Press the [NAME.S] button for at least 2 seconds.

The presently selected AUX Name is displayed.



### 3 Select the Auxiliary input display

Press the [◀] or [▶] button.

Each time the button is pressed it switches through the below displays.

- "AUX"
- "TV"
- "VCP"
- "GAME"
- "PORTABLE"

### 4 Exit Auxiliary input display setting mode

Press the [NAME.S] button.



When operation stops for 10 seconds, the name at that time is selected, and Auxiliary input display setting mode closes.

## Faceplate Angle Adjustment

Press the [ANG] button for at least 1 second.



- Do not apply excessive force to the faceplate. It can cause damage.
- The faceplate angle cannot be adjusted during tape play.

## Theft Deterrent Faceplate

The faceplate of the unit can be detached and taken with you, helping to deter theft.

### Removing the Faceplate

- 1 Turn the ignition OFF or press the [SRC] button for at least 1 second.  
The power turns OFF and the faceplate slides open.
- 2 Holding the center part of the faceplate pull it out.

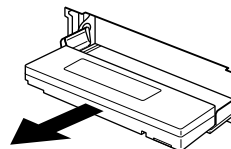

- When the faceplate is kept remove open, according to the <OFF Wait Time Setting> (page 19) setting, the faceplate is hidden and the power turns OFF.
- The faceplate is a precision piece of equipment and can be damaged by shocks or jolts. For that reason, keep the faceplate in its special storage case while detached.
- Do not expose the faceplate or its storage case to direct sunlight or excessive heat or humidity. Also avoid places with too much dust or the possibility of water splashing.

### Reattaching the Faceplate

- 1 Set the left side of the faceplate in the faceplate bracket.

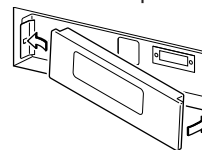

- 2 Press the right side of the faceplate until it locks.



## Tuning Mode

Choose the tuning mode.

Press the [AUTO] button.

Each time the button is pressed the Tuning mode switches as shown below.

<b>Tuning mode</b>	<b>Display</b>	<b>Operation</b>
Auto seek	"Auto1"	Automatic search for a station.
Preset station seek	"Auto2"	Search in order of the stations in the Preset memory.
Manual	"Manual"	Normal manual tuning control.

## Tuning

Selecting the station.

### 1 Select tuner source

Press the [SRC] button.

Select the "TUNER" display.

### 2 Select the band

Press the [FM] or [AM] button.

Each time the [FM] button is pressed it switches between the FM1, FM2, and FM3 bands.

### 3 Tune up or down band

Press the [◀◀] or [▶▶] button.



During reception of stereo stations the "ST" indicator is ON.

## Direct Access Tuning (Function of remote)

Entering the frequency and tuning.

### 1 Select the band

Press the [FM] or [AM] button.

### 2 Enter Direct Access Tuning mode

Press the [DIRECT] button on the remote.

The "----" display.

### 3 Enter the frequency

Press the number buttons on the remote.

Example:

<b>Desired frequency</b>	<b>Press button</b>
92.1 MHz (FM)	[#0], [#9], [#2], [#1]
810 kHz (AM)	[#0], [#8], [#1], [#0]

### Canceling Direct Access Tuning

Press the [DIRECT] button on the remote.

## Station Preset Memory

Putting the station in the memory.

### 1 Select the band

Press the [FM] or [AM] button.

### 2 Select the frequency to put in the memory

Press the [◀◀] or [▶▶] button.

### 3 Put the frequency in the memory

Press the [#1] — [#6] button for at least 2 seconds.

The preset number display blinks 1 time.

On each band, 1 station can be put in the memory on each [#1] — [#6] button.

## Tuner features

### Auto Memory Entry

Putting stations with good reception in the memory automatically.

#### 1 Select the band for Auto Memory Entry

Press the [FM] or [AM] button.

#### 2 Open Auto Memory Entry

Press the [AME] button for at least 2 seconds.

When 6 stations that can be received are put in the memory Auto Memory Entry closes.

### Preset Tuning

Calling up the stations in the memory.

#### 1 Select the band

Press the [FM] or [AM] button.

#### 2 Call up the station

Press the [#1] — [#6] button.

### Frequency Step Setting

Changing the tuning frequency step.

The original setting is FM band 50 kHz, and AM band 9 kHz.

While pressing the [#1] and [#5] button, press the Reset button.

The frequency step changes to FM band 200 kHz, and AM band 10 kHz.



- When the same operation is repeated, it returns to the original setting.
- When the frequency step is switched, the frequencies in the memory are deleted.

## Cassette player features

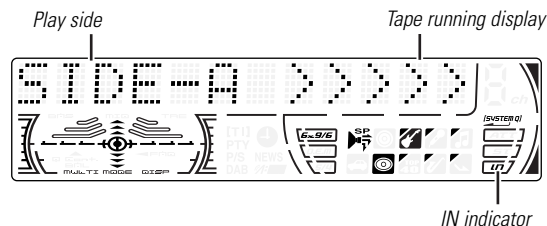
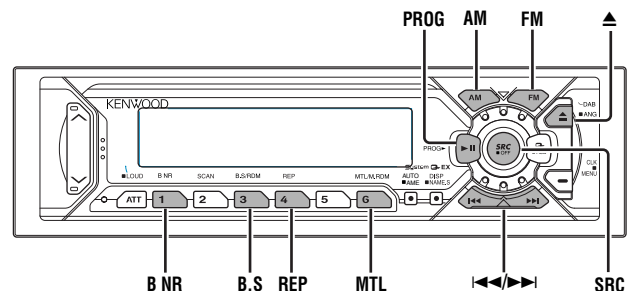

## Playing Cassette Tapes

### When there's no Cassette Tape inserted

#### 1 Slide open the faceplate

Press the [▲] button.

#### 2 Insert a Cassette Tape.

 When the faceplate has been slid open, it might interfere with the shift lever or something else. If this happens, pay attention to safety and move the shift lever or take an appropriate action, then operate the unit.

-  The sound will be temporarily muted while the faceplate is moving.
- When there's a Cassette Tape inserted, the "IN" indicator is ON.

### When there's a Cassette Tape inserted

Press the [SRC] button.

Select the "TAPE" display.

### When you want to listen to the reverse side

Press the [PROG] button.

### Eject the Cassette Tape

#### 1 Eject the Cassette Tape

Press the [▲] button.

#### 2 Close the faceplate

Press the [▲] button.

## Fast Forwarding and Rewinding

### Fast Forwarding

Press the [FM] button.

When it's stopped press the [PROG] button.

### Rewinding

Press the [AM] button.

When it's stopped press the [PROG] button.

## Dolby B NR

Press the [B NR] button.

Each time the button is pressed the Dolby B NR turns ON or OFF.

When it's ON, "B-NR ON" is displayed.

## Selecting the Tape type

Press the [MTL] button.

Each time the button is pressed the Tape type switches as shown below.

<u>Tape type</u>	<u>Display</u>
CrO <sub>2</sub> (Type II), FeCr (Type III), Metal (Type IV)	"Metal ON"
Normal (Type I)	"Metal OFF"

## DPSS (Direct Program Search System)

Indicating the songs to skip, and Fast Forwarding or Rewinding.

### Skipping to a later song

Press the [▶▶] button.

Each time the button is pressed the number of songs skipped increases.

### Skipping to a previous song

Press the [◀◀] button.

Each time the button is pressed the number of songs skipped increases.

### Canceling DPSS

Press the [PROG] button.



- During the songs first 5 seconds there may be a times when the previous song is recognized as the current song.
- As many as 9 songs can be skipped.

## Cassette player features

### DPSS with the Remote

Designating the song to be skipped with the remote control number buttons.

#### 1 Designate the song to skip

Press number buttons on the remote.

#### 2 Skipping to a later song

Press the [▶▶] button.

#### Skipping to a previous song

Press the [◀◀] button.

### Canceling DPSS

Press the [▶||] button.



- During the songs first 5 seconds there may be a times when the previous track is recognized as the current track.
- As many as 9 songs can be skipped.

### Blank Skip

Fast forwarding automatically when an unrecorded portion continues for at least 10 seconds.

Press the [B.S] button.

Each time the button is pressed the Blank Skip turns ON or OFF. When it's ON, "B.Skip ON" is displayed.

### Music Repeat

Repeating the present song.

Press the [REP] button.

Each time the button is pressed the Music Repeat turns ON or OFF.

When it's ON, "Repeat ON" is displayed.

## External disc control features

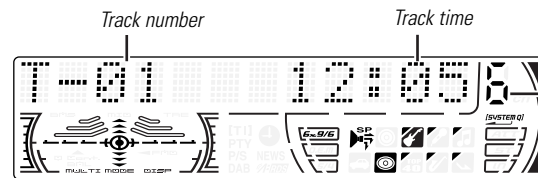
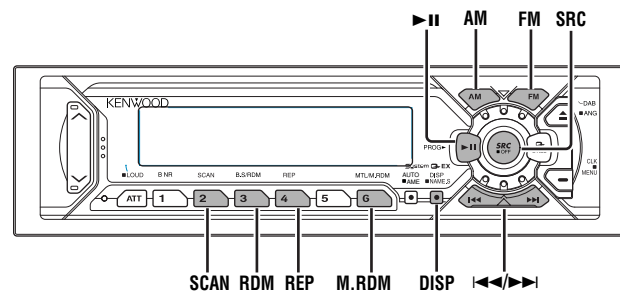

Disc number

## Playing External Disc

Playing discs set in the optional accessory disc player connected to this unit.

Press the [SRC] button.

Select the display for the disc player you want.

Display examples:

Display	Disc player
"CD"	CD player
"DISC"	CD changer / MD changer

### Pause and play

Press the [▶||] button.

Each time the button is pressed it pauses and plays.

-  Disc #10 is displayed as "0".
- The functions that can be used and the information that can be displayed will differ depending on the external disc players being connected.

## Fast Forwarding and Reversing

### Fast Forwarding

Hold down on the [▶▶] button.

Release your finger to play the disc at that point.

### Reversing

Hold down on the [◀◀] button.

Release your finger to play the disc at that point.

## Track Search

Selecting the song you want to hear.

Press the [◀◀] or [▶▶] button.

## Album Search (Function of disc changer)

Selecting the disc you want to hear.

Press the [AM] or [FM] button.

## Direct Track Search (Function of remote)

Doing Track Search by entering the track number.

### 1 Enter the track number

Press the number buttons on the remote.

### 2 Do Track Search

Press the [◀◀] or [▶▶] button.

### Canceling Direct Track Search

Press the [▶||] button.

## Direct Album Search (Function of disc changers with remote)

Doing Disc Search by entering the disc number.

### 1 Enter the disc number

Press the number buttons on the remote.

### 2 Do Album Search

Press the [DISC+] or [DISC-] button.

### Canceling Direct Album Search

Press the [▶||] button.

-  Input "0" to select disc 10.

## External disc control features

### Track/Album Repeat

Replaying the track/disc you're listening to.

Press the [REP] button.

Each time the button is pressed the Repeat Play switches as shown below.

Repeat play	Display
Track Repeat	"T-Repeat ON"/ " Repeat ON"
Album Repeat (Function of disc changer)	"D-Repeat ON"
OFF	"Repeat OFF"

### Track Scan

Playing the first part of each song on the disc you are listening to and searching for the song you want to listen to.

#### 1 Start Track Scan

Press the [SCAN] button.

"Scan ON" is displayed.

#### 2 Release it when the song you want to listen to is played

Press the [SCAN] button.

### Random Play

Playing all the songs on the disc in random order.

Press the [RDM] button.

Each time the button is pressed Random Play turns ON or OFF.

When it's ON, "Random ON" is displayed.



When the [▶▶] button is pressed, the next song select starts.

### Magazine Random Play

#### (Function of disc changer)

Play the songs on all the discs in the disc changer in random order.

Press the [M.RDM] button.

Each time the button is pressed the Magazine Random Play turns ON or OFF.

When it's ON, "M.Random ON" is displayed.



When the [▶▶] button is pressed, the next song select starts.

### Text/Title Scroll

Scrolling the displayed CD text or MD title.

Press the [DISP] button for at least 1 second.

### DNPP (Disc Name Preset Play)

#### (Function of disc changers with remote)

Selecting the CD displayed in the DNPS of the CDs set in the Disc changer.

#### 1 Enter DNPP mode

Press the [DNPP] button on the remote.

When "DNPP" is displayed the DNPS display in order.

#### Forward / Reverse display

Press the [DISC-] or [DISC+] button.

#### 2 When the disc you want is displayed

Press the [OK] button on the remote.

The disc being displayed is played.

#### Canceling the DNPP mode

Press the [DNPP] button on the remote.



## Menu system

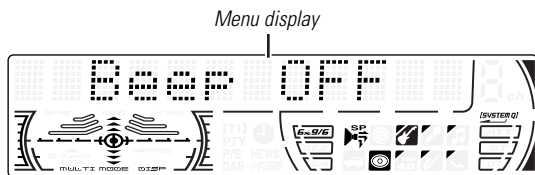
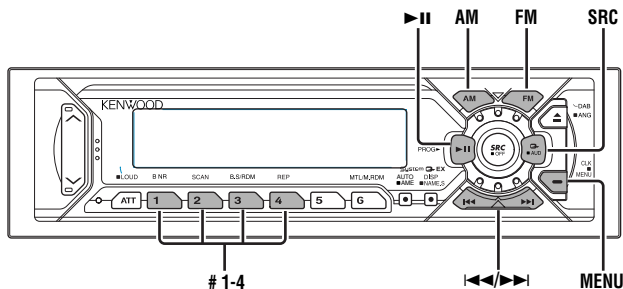

### Menu System

Setting during operation beep sound etc. functions. The Menu system basic operation method is explained here. The reference for the Menu items and their setting content is after this operation explanation.

#### 1 Enter Menu mode

Press the [MENU] button for at least 1 second.

"MENU" is displayed.

#### 2 Select the menu item

Press the [FM] or [AM] button.

Example: When you want to set the beep sound select the "Beep" display.

#### 3 Set the menu item

Press the [◀◀] or [▶▶] button.

Example: When "Beep" is selected, each time the button is pressed it switches "Beep ON" or "Beep OFF". Select 1 of them as the setting.

You can continue by returning to step 2 and setting other items.

#### 4 Exit Menu mode

Press the [MENU] button.



When other items that are applicable to the basic operation method above are displayed afterwards their setting content chart is entered. (Normally the uppermost setting in the chart is the original setting.)

Also, the explanation for items that aren't applicable (<Manual Clock Adjustment>etc.) are entered step by step.

## Menu system

### Security Code

Because authorization by the Security Code is required when it's removed from the vehicle, personalizing this unit is by using the Security Code is a help in preventing theft.

 When the Security Code function is activated it can't be released. Note, your Security Code is the 4 digit number entered in your "Car Audio Passport" in this package.

#### 1 Enter Standby

Press the [SRC] button.

Select the "ALL OFF" display.

#### 2 Enter Menu mode

Press the [MENU] button for at least 1 second.

When "MENU" is displayed, "Security" is displayed.

#### 3 Enter Security Code mode

Press the [◀◀] or [▶▶] button for at least 1 second.

When "ENTER" is displayed, "CODE" is displayed.

#### 4 Enter the Security Code

Press the [#1] — [#4] button.

Example: If your Security Code is "3510".

Step	Button	#Times pressed	Display
1	[#1]	4	"3"
2	[#2]	6	"5"
3	[#3]	2	"1"
4	[#4]	1	"0"

#### 5 Confirm the Security Code

Press the [DISP] button for at least 3 seconds.

When "RE-ENTER" is displayed, "CODE" is displayed.

#### 6 Do the step 4 and 5 step operation, and reenter the security code.

"APPROVED" is displayed.

The Security Code function activates.



If you enter a Code different from your Security Code, you have to start over from step 4.

### Press the Reset button and when it's removed from the battery power source

#### 1 Turn the power ON.

#### 2 Do the step 4 and 5 operation, and enter the Security Code.

"APPROVED" is displayed.

The unit can be used.



If an incorrect code is input, "WAITING" is displayed, and the input prohibited time shown below is generated.

After the input prohibited time lapses, "CODE" is displayed, and input can be done.

Number of times the incorrect code was input	Input prohibited time
1	—
2	5 minutes
3	1 hour
4	24 hours

### Touch Sensor Tone

Setting the operation check sound (beep sound) ON/OFF.

Display	Setting
"Beep ON"	Beep is heard.
"Beep OFF"	Beep canceled.

### Manual Clock Adjustment

#### 1 Select Clock Adjustment mode

Press the [FM] or [AM] button.

Select the "Clock Adjust" display.

## 2 Enter Clock Adjust mode

Press the [◀◀] or [▶▶] button for at least 1 second.  
The clock display blinks.

## 3 Adjust the hours

Press the [FM] or [AM] button.

### Adjust the minutes

Press the [◀◀] or [▶▶] button.

## 4 Exit Clock adjustment mode

Press the [MENU] button.

## Selectable Illumination

Selecting the button illumination color as green or red.

Display	Setting
"Button Green"	The illumination color is green.
"Button Red"	The illumination color is red.

## Switching Graphic Display

Setting the graphic part display ON/OFF.

Display	Setting
"Graphic ON"	The graphic part is displayed.
"Graphic OFF"	The graphic part isn't displayed.

## Contrast Adjustment

Adjusting the display contrast.

### Display and Setting

"Contrast 0"
:
"Contrast 5" (Original setting)
:
"Contrast 10"

## Dimmer

Dimming this unit's display automatically when the vehicle light switch is turned ON.

Display	Setting
"Dimmer ON"	The display dims.
"Dimmer OFF"	The display doesn't dim.

## OFF Wait Time Setting

Setting the time until the faceplate hide operation starts after the power is turned OFF.

The faceplate can be removed only during the set time period.

### Display and Setting

"Off Wait 0s"
:
"Off Wait 3s" (Original setting)
:
"Off Wait 25s"

## Menu system

### System Q

Setting display/don't display for the System Q factors (Bass center frequency, Bass Q factor, Bass extend, Middle center frequency, Middle Q factor, and Treble center frequency) in Audio control.

Display	Setting
"System Q ON"	The System Q factors are displayed.
"System Q OFF"	The System Q factors aren't displayed.

### B.M.S. (Bass Management System)

Adjust the bass boost level of the external amplifier using the main unit.

Display	Setting
"AMP Bass FLT"	Bass boost level is flat.
"AMP Bass +6"	Bass boost level is low (+6dB).
"AMP Bass +12"	Bass boost level is mid (+12dB).



Refer to the catalog or instruction manual for power amplifiers that can be controlled from this unit.

### CRSC (Clean Reception System Circuit) <In FM reception>

Temporarily have reception switched from stereo to mono to reduce multi-path noise when listening to the FM station.

Display	Setting
"CRSC ON"	The CRSC is ON.
"CRSC OFF"	The CRSC is OFF.



Strong electrical fields (such as from power lines) may cause unstable sound quality when CRSC is turned ON. In such a situation, turn it OFF.

### Text Scroll <In External disc control mode>

Setting the displayed text scroll.

Display	Setting
"Scroll Auto"	Repeats scroll.
"Scroll MANU"	Scrolls when the display changes.



The text scrolled is shown below.

- CD text
- MD title

## Basic Operations of remote

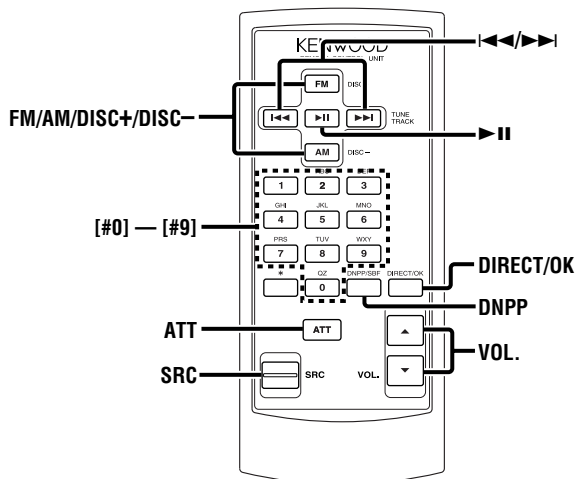

## Loading and Replacing the battery

Use one lithium battery (CR2025).  
Insert the batteries with the + and – poles aligned properly, following the illustration inside the case.

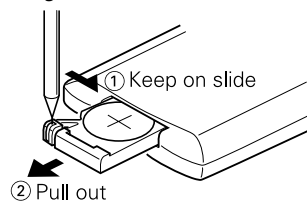

### ⚠ WARNING

Store unused batteries out of the reach of children. Contact a doctor immediately if the battery is accidentally swallowed.

⚠ Do not set the remote on hot places such as above the dashboard.

## Basic operations

### [VOL.] buttons

Adjusting the volume.

### [SRC] button

Each time the button is pressed the source switches.  
For the source switching order refer to <Selecting the Source> (page 5).

### [ATT] button

Turning the volume down quickly.  
When it is pressed again it returns to the previous level.

## Basic Operations of remote

### In Tuner source

#### [FM]/ [AM] buttons

Select the band.

Each time the [FM] button is pressed it switches between the FM1, FM2, and FM3 bands.

#### [◀◀]/ [▶▶] buttons

Tune up or down band.

#### [#0] — [#9] buttons

Press buttons [#1] — [#6] to recall preset stations.

#### [DIRECT] button

Enters and cancels the <Direct Access Tuning> (page 11) mode.

### In Cassette tape source

#### [◀◀]/ [▶▶] buttons

Do <DPSS (Direct Program Search System)> (page 13).

#### [▶II] button

Plays the reverse side of the tape.

#### [FM ] button

Fast forwards the tape.

When the [▶II] button is pressed it releases.

#### [AM] button

Rewinds the tape.

When the [▶II] button is pressed it can be released.

#### [#0] — [#9] buttons

When in <DPSS with the Remote> (page 14) enter the number of songs.

### In Disc source

#### [◀◀]/ [▶▶] buttons

Doing track forward and backward.

#### [DISC+]/ [DISC-] buttons

Doing album forward and backward.

#### [▶II] button

Each time the button is pressed the song pauses and plays.

#### [DNPP]/ [OK] button

Enters and cancels the <DNPP (Disc Name Preset Play)> (page 16) mode.

#### [#0] — [#9] buttons

When in <Direct Track Search> (page 15) and <Direct Album Search> (page 15), enter the track/disc number.

## Accessories

### External view

..... Number of items

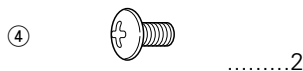
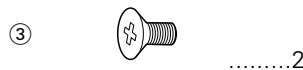
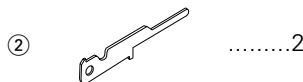
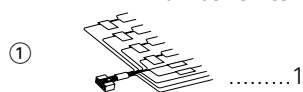

### External view

..... Number of items

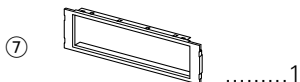
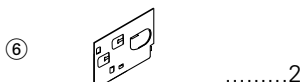

Do not use any accessories other than those provided with your unit. If you use other accessories, you may damage the unit.

## Installation Procedure

1. To prevent a short circuit, remove the key from the ignition and disconnect the  $\ominus$  battery.
2. Make the proper input and output wire connections for each unit.
3. Connect the speaker wires of the wiring harness.
4. Connect the wiring harness wires in the following order: ground, battery, ignition.
5. Connect the wiring harness connector to the unit.
6. Install the unit in your car.

7. Reconnect the  $\ominus$  battery.
8. Press the left part at the upper side of the faceplate once to make the faceplate control panel appear.

### ▲WARNING

If you connect the ignition wire (red) and the battery wire (yellow) to the car chassis (ground), you may cause a short circuit, that in turn may start a fire. Always connect those wires to the power source running through the fuse box.

### ▲CAUTION

- If your car's ignition does not have an ACC position, connect the ignition wires to a power source that can be turned on and off with the ignition key. If you connect the ignition wire to a power source with a constant voltage supply, as with battery wires, the battery may die.
- If the console has a lid, make sure to install the unit so that the faceplate will not hit the lid when closing and opening.
- If the fuse blows, first make sure the wires aren't touching to cause a short circuit, then replace the old fuse with one with the same rating.
- Insulate unconnected wires with vinyl tape or other similar material. To prevent a short circuit, do not remove the caps on the ends of the unconnected wires or the terminals.
- Connect the speaker wires correctly to the terminals to which they correspond. The unit may be damaged or fail to work if you share the  $\ominus$  wires or ground them to any metal part in the car.
- When only two speakers are being connected to the system, connect the connectors either to both the front output terminals or to both the rear output terminals (do not mix front and rear). For example, if you connect the  $\oplus$  connector of the left speaker to a front output terminal, do not connect the  $\ominus$  connector to a rear output terminal.
- After the unit is installed, check whether the brake lamps, blinkers, wipers, etc. on the car are working properly.





## Installation (non-Japanese cars)

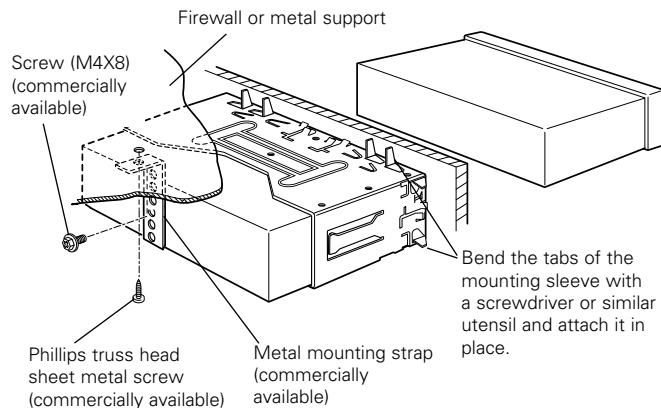

Make sure that the unit is installed securely in place. If the unit is unstable, it may malfunction (for example, the sound may skip).

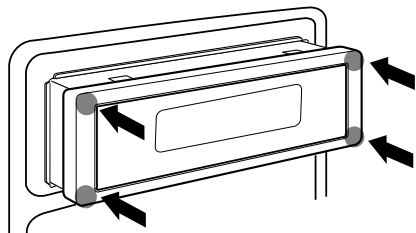

**!** To attach this unit, make sure the front of the control panel faces you and fit it into the mounting sleeve by pressing the four corners of the hard rubber frame at the same time. Do not apply strong pressure to other sections than the corners; otherwise troubles such as the impossibility of opening or closing the panel may result.

## Installation (Japanese cars)

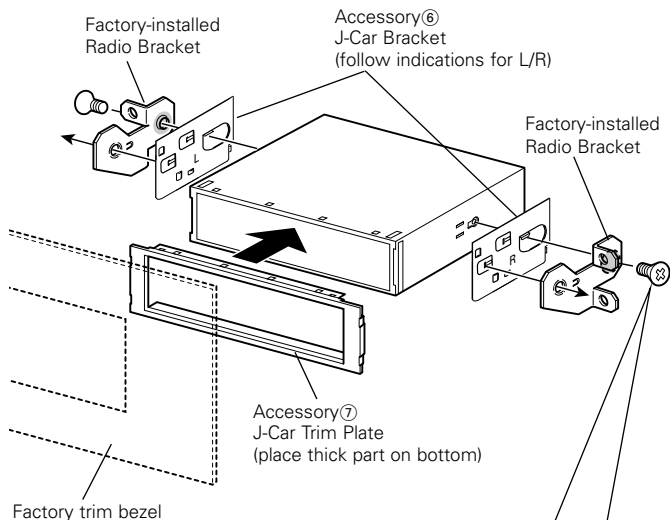

### For Toyota Car

After aligning the factory-installed radio bracket, tighten the screws.



### For Nissan Car

After aligning the J-Car bracket with the factory-installed radio bracket, tighten the screws.



**!** Damage to the unit will result from using screws other than those provided.

A pair of J-Car Brackets (Accessory ⑥) are not used when fitting in a Toyota car.

## Removing the Unit

- 1 Insert the removal tool into the indentations in the hard rubber frame, and pull it gently until the lock is released.

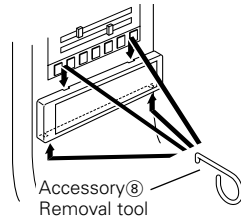

- 2 Remove the screw (M4X8) on the back panel.
- 3 Insert the two removal tools deeply into the slots on each side, as shown.

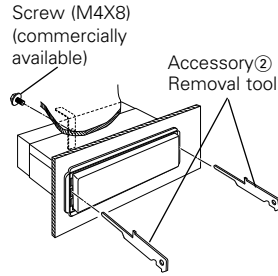

- 4 Push upward the removal tool toward the top, and pull out the unit halfway while pressing towards the inside.

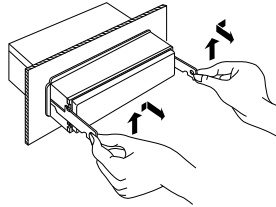

 Be careful to avoid injury from the catch pins on the removal tool.

- 5 Pull the unit all the way out with your hands, being careful not to drop it.

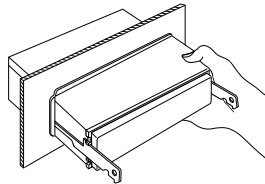

## Locking the faceplate to the unit

If you want to lock the faceplate to the unit so that it does not fall off, follow the directions below.

- 1 Refer to the function "Removing the faceplate" (page 9) and remove the faceplate.
- 2 Insert the provided screw into the hole at the center of the bottom side of the faceplate which you have removed from the unit.

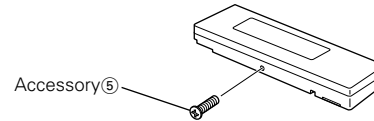

- 3 Refer to the section "Removing the faceplate" (page 9) and then reattaching the faceplate.

 Never insert the tapite screws (ø2 X 4 mm) in any other screw holes than the one specified. If you insert it in another hole, it will contract and may cause damage to the mechanical parts inside the unit.

## Troubleshooting Guide

---

What might seem to be a malfunction in your unit may just be the result of slight misoperation or miswiring. Before calling service, first check the following table for possible problems.

### General

#### ? The power does not turn ON.

- ✓ The fuse has blown.
    - ⓘ After checking for short circuits in the wires, replace the fuse with one with the same rating.
  - ✓ No ACC position on vehicle ignition.
    - ⓘ Connect the same wire to the ignition as the battery wire.
- 

#### ? Nothing happens when the buttons are pressed.

- ✓ The computer chip in the unit is not functioning normally.
    - ⓘ Press the reset button on the unit (page 4).
- 

#### ? There's a source you can't switch.

- ✓ There's no tape inserted.
    - ⓘ Set the media you want to listen to. If there's no media in this unit, you can't switch to each source.
  - ✓ The Disc changer isn't connected.
    - ⓘ Connect the Disc changer. If the Disc changer isn't connected to its input terminal, You can't switch to an external disc source.
- 

#### ? The faceplate does not open or close.

- ✓ The faceplate is incorrectly attached.
    - ⓘ Reattach the faceplate correctly. See the section on <Removing the Faceplate>(page 9).
- 

#### ? The memory is erased when the ignition is turned OFF.

- ✓ The battery wire has not been connected to the proper terminal.
    - ⓘ Connect the wire correctly, referring to the section on <Connecting Wires to Terminals>.
  - ✓ The ignition and battery wire are incorrectly connected.
    - ⓘ Connect the wire correctly, referring to the section on <Connecting Wires to Terminals>.
- 

#### ? Even if Loudness is turned ON, high-pitched tone isn't compensated for.

- ✓ Tuner source is selected.
    - ⓘ High-pitched tone isn't compensated for when in Tuner source.
- 

#### ? The Bass center frequency, Bass quality factor, Bass extend, Middle center frequency, Middle quality factor, and Treble center frequency can't be adjusted.

- ✓ The <System Q> (page 20) is set OFF.
    - ⓘ Set it ON.
- 

#### ? No sound can be heard, or the volume is low.

- ✓ The fader or balance settings are set all the way to one side.
    - ⓘ Center the fader and balance settings.
  - ✓ The input/output wires or wiring harness are connected incorrectly.
    - ⓘ Reconnect the input/output wires or the wiring harness correctly. See the section on <Connecting Wires to Terminals>.
  - ✓ The cassette tape is bad.
    - ⓘ Try playing another cassette tape. If works fine, the first tape was bad.
  - ✓ The values of Volume offset are low.
    - ⓘ Increase the values of Volume offset. (page 6)
- 

#### ? The sound quality is poor or distorted.

- ✓ One of the speaker wires is being pinched by a screw in the car.
    - ⓘ Check the speaker wiring.
  - ✓ The tape head is dirty.
    - ⓘ Clean the tape head.
  - ✓ The speakers are not wired correctly.
    - ⓘ Reconnect the speaker wires so that each output terminal is connected to a different speaker.
- 

#### ? The Security Code item isn't displayed in the Menu System.

- ✓ The Security Code function is already activated.
    - ⓘ When the Security Code function is activated it isn't displayed in the menu items.
- 

#### ? The Touch Sensor Tone doesn't sound.

- ✓ The preout jack is being used.
    - ⓘ The Touch Sensor Tone can't be output from the preout jack.
- 

#### ? Even though the vehicle light switch is turned ON, the unit's display won't dim.

- ✓ The dimmer wire isn't connected.
    - ⓘ Connect the dimmer wire correctly.
- 

#### ? The Dimmer function doesn't work.

- ✓ The dimmer wire isn't connected correctly.
    - ⓘ Check the Dimmer wire connection.
-

## Troubleshooting Guide

### Tuner source

#### ? Radio reception is poor.

- ✓ The car antenna is not extended.  
☞ Pull the antenna out all the way.

---

- ✓ The antenna control wire is not connected.  
☞ Connect the wire correctly, referring to the section on <Connecting Wires to Terminals>.

#### ? The desired frequency can't be entered with the Direct Access Tuning.

- ✓ A station that can't be received is being entered.  
☞ Enter a station that can be received.

---

- ✓ You're trying to enter a frequency with a 0.01 MHz unit.  
☞ What can be designated in the FM band is to 0.1 MHz.

### Cassette tape source

#### ? Can't remove tape.

- ✓ The cause is that more than 10 minutes has elapsed since the vehicle ACC switch was turned OFF.  
☞ The tape can only be removed within 10 minutes of the ACC switch being turned OFF. If more than 10 minutes has elapsed, turn the ACC switch ON again and press the Eject button.

#### ? The DPSS, Tape Advance and Music Repeat don't operate correctly.

- ✓ The space between the songs on the tape can't be recognized because it's too short.  
☞ Have at least 4 seconds between songs.

---

- ✓ The space between songs can't be recognized because there's too much noise between songs.  
☞ Reduce the noise between songs.

#### ? The blank skip doesn't work.

- ✓ Because noise is too loud, the non-recorded part can't be recognized.  
☞ Reduce the noise between songs.

#### ? Blank Skip functions at places that are recorded.

- ✓ Because the recording level is low, it's recognized as not recorded.  
☞ Turn Blank Skip OFF.

### Disc source

#### ? "AUX" is displayed without achieving External disc control mode.

- ✓ O-N switch is set to "O" side.  
☞ Set the switch to "N" side.

---

- ✓ Unsupported disc changer is connected.  
☞ Connect the supported disc changer. (page 3)

#### ? The specified disc does not play, but another one plays instead.

- ✓ The specified CD is quite dirty.  
☞ Clean the CD.

---

- ✓ The CD is upside-down.  
☞ Load the CD with the labeled side up.

---

- ✓ The disc is loaded in a different slot from that specified.  
☞ Eject the disc magazine and check the number for the specified disc.

---

- ✓ The disc is severely scratched.  
☞ Try another disc instead.

#### ? The specified track will not play.

- ✓ Random play or magazine random play has been selected.  
☞ Turn off random play or magazine random play.

#### ? Track repeat, disc repeat, track scan, random play, and magazine random play start by themselves.

- ✓ The setting is not canceled.  
☞ The settings for these functions remain on until the setting to off or the disc ejected, even if the power is turned off or the source changed.

#### ? Cannot play CD-R or CD-RW.

- ✓ Finalization processing is not being conducted for CD-R/CD-RW.  
☞ Conduct finalization processing with CD recorder.

---

- ✓ A non-compatible CD changer is being used to play the CD-R/CD-RW.  
☞ Use a CD changer compatible with CD-R/CD-RW to play.

#### ? Direct Track Search and Direct Disc Search can't be done.

- ✓ Another function is ON.  
☞ Turn Random Play or other functions OFF.

#### ? Track Search can't be done.

- ✓ For the albums first or last song.  
☞ For each album, Track Search can't be done in the backward direction for the first song or in the forward direction for the last song.

## Troubleshooting Guide

---

### The messages shown below display your systems condition.

Eject:	No disc magazine has been loaded in the changer. The disc magazine is not completely loaded. ⇨ Load the disc magazine properly. No CD in the unit. ⇨ Insert the CD.
No Disc:	No disc has been loaded in the disc magazine. ⇨ Load a disc into the disc magazine.
TOC Error:	No disc has been loaded in the disc magazine. ⇨ Load a disc into the disc magazine. The CD is quite dirty. The CD is upside-down. The CD is scratched a lot. ⇨ Clean the CD and load it correctly.
Blank DISC:	Nothing has been recorded on the MD.
No Tr DISC:	No tracks are recorded on the MD, although it has a title.
NO PANEL:	The faceplate of the slave unit being connected to this unit has been removed. ⇨ Replace it.
E-77:	The unit is malfunctioning for some reason. ⇨ Press the reset button on the unit. If the "E-77" code does not disappear, consult your nearest service center.
Mecha Error:	Something is wrong with the disc magazine. Or the unit is malfunctioning for some reason. ⇨ Check the disc magazine. And then press the reset button on the unit. If the "Mecha Error" code does not disappear, consult your nearest service center.
Hold Error:	The protective circuit in the unit activates when the temperature inside the automatic disc changer exceeds 60°C (140°F), stopping all operation. ⇨ Cool down the unit by opening the windows or

turning on the air conditioner. As the temperature falls below 60°C (140°F), the disc will start playing again.

NO NAME:	<ul style="list-style-type: none"><li>• Attempted to display SNPS during the receiving session of the station having no station name preset.</li><li>• Attempted to display DNPS during the CD play having no disc names preset.</li></ul>
NO TITLE:	Attempted to display the disc title or track title while the MD having no MD title is being played.
NO TEXT:	Attempted to display the disc text or track text while the CD having no CD text is being played.
Load:	Discs are being exchanged in the Disc changer.
NO ACCESS:	After setting it in the Disc Changer, DNPP was done without having it been played at least 1 time.
IN (Blink):	The tape player section is not operating properly. ⇨ Reinsert the Tape. If the tape cannot be ejected or the display continues to flash even when the tape has been properly reinserted, please switch off the power and consult your nearest service center.
NOT.AVAILABLE:	Adjust the panel angle during tape play.

### If the following situations, consult your nearest service center:

- Even though the disc changer is connected, the Disc Changer source is not ON, with "AUX" showing in the display during the Changer Mode.
- Even though no device (KCA-S210A, CA-C1AX, KDC-CPS87, KDC-CX87, KDC-CPS85, KDC-CX85, KDC-CPS82 or KDC-CX82) is connected, the Auxiliary input is entered when switching modes.

## Specifications

Specifications subject to change without notice.

### FM tuner section

Frequency range	
(50 kHz)	87.5 MHz – 108.0 MHz
(200 kHz)	87.9 MHz – 107.9 MHz
Usable sensitivity (S/N = 30dB)	9.3dBf (0.8 $\mu$ V/75 $\Omega$ )
Quieting Sensitivity (S/N = 50dB)	15.2dBf (1.6 $\mu$ V/75 $\Omega$ )
Frequency response ( $\pm$ 3.0 dB)	30 Hz – 15 kHz
Signal to Noise ratio (MONO)	70 dB
Selectivity ( $\pm$ 400 kHz)	$\geq$ 80 dB
Stereo separation (1 kHz)	40 dB

### AM tuner section

Frequency range	
(9 kHz)	531 kHz – 1611 kHz
(10 kHz)	530 kHz – 1700 kHz
Usable sensitivity (S/N = 20dB)	28 dB $\mu$ (25 $\mu$ V)

### Cassette player section

Tape Speed	4.76 cm/sec.
Wow & Flutter (WRMS)	0.08 %
Frequency response ( $\pm$ 3 dB) (70 $\mu$ s)	30 Hz – 20 kHz
Separation (1 kHz)	43 dB
Signal to Noise ratio	
Dolby NR OFF	57 dB
Dolby B NR ON	65 dB

### Audio section

Maximum output power	47 W $\times$ 4
Full Bandwidth Power (at less than 1% THD)	22 W $\times$ 4
Tone action	
Bass	100 Hz $\pm$ 10 dB
Middle	1 kHz $\pm$ 10 dB
Treble	10 kHz $\pm$ 10 dB
Preout level / Load (during disc play)	1800 mV / 10 k $\Omega$
Preout impedance	$\leq$ 600 $\Omega$

### General

Operating voltage (11 – 16V allowable)	14.4 V
Current consumption	10 A
Installation Size (W $\times$ H $\times$ D)	182 x 53 x 161 mm
Weight	1.4 kg